



Association of Arab Universities Protect, Monitor and Trace Academic Certificates, Diplomas, and Transcripts



Dr. Mohammad Jilani, CEO

www.verifycct.com

Mohammad.jilani@cctinc.com



Welcome!

Association of Arab Universities

Presents

Arab Students Clearing House

To the 39th Conference of

ARAB ACRAO

Presentation Agenda

01

Introduction

Clearing House

02

Shocking Forgery Facts

Shocking facts

03

Proposed Solution

Our innovative solution

04

Benefits

Benefits for all

05

Contact us

Keep in touch

1

Introduction



Arab Student Clearinghouse

MISSION

The mission of the Arab Student Clearinghouse is to serve the education and workforce communities and all learners with access to trusted data, related services, and insights.

VISION

To be a premier resource in serving and supporting the opportunities created by lifelong learning.

OBJECTIVE

*Protect - Trace - Verify - Digitize
Transcripts and Vital Documents
For Arab Students
Anytime, Anywhere*

Solutions

Trace & Monitor

Monitors and traces all transactions performed on diplomas and certificates.

Verification

Allows online, real-time instant verification of all academic documents.



Authentication

Innovative technology secures certificates, diplomas, transcripts, and other academic documents

100% Counterfeit Protection

Guarantees 100% detection of any type of forgery in a seamless, accurate and fast manner.

Diploma Forgery Shocking Facts

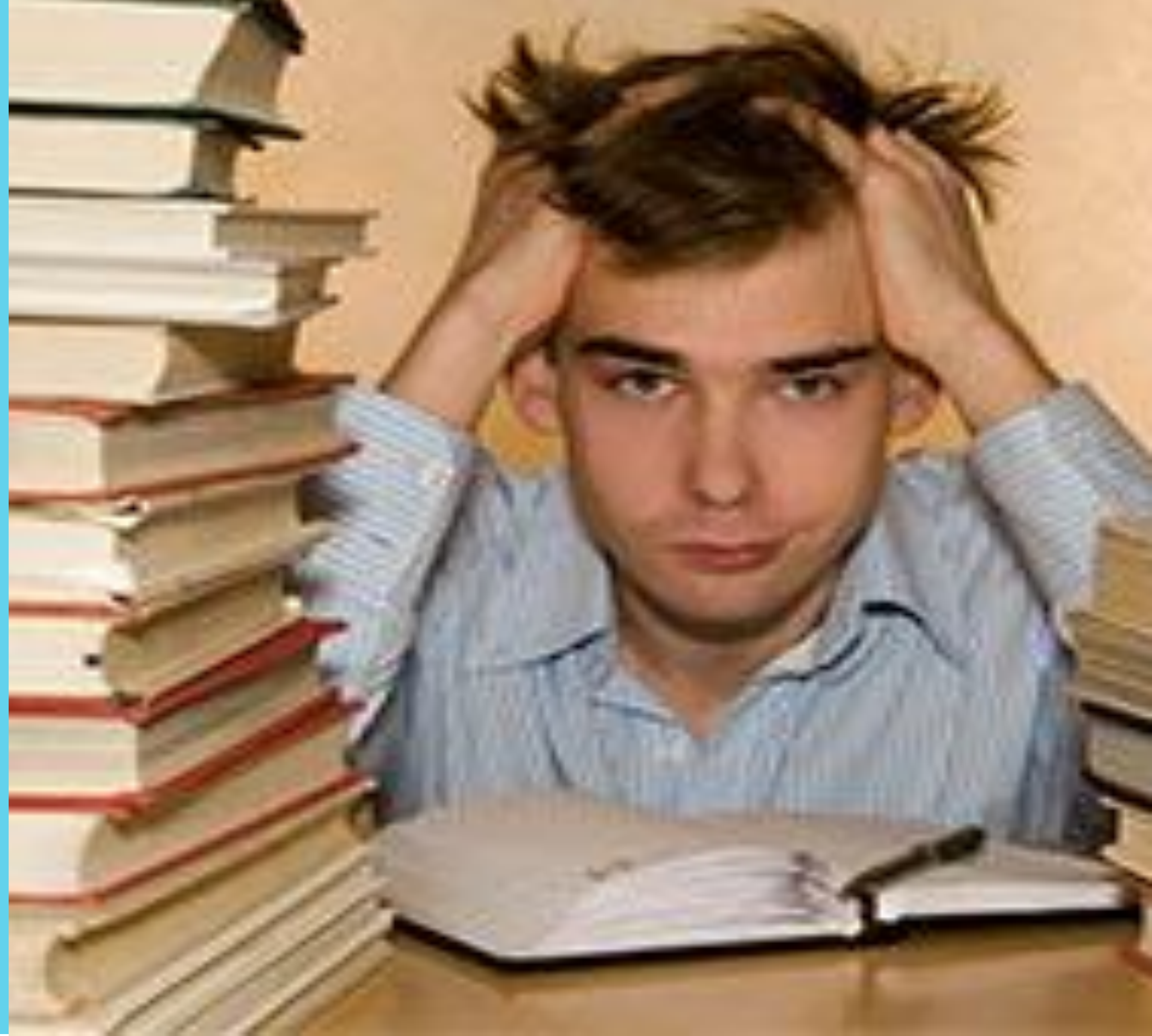

Certificate Forgery: No Nation is Immune

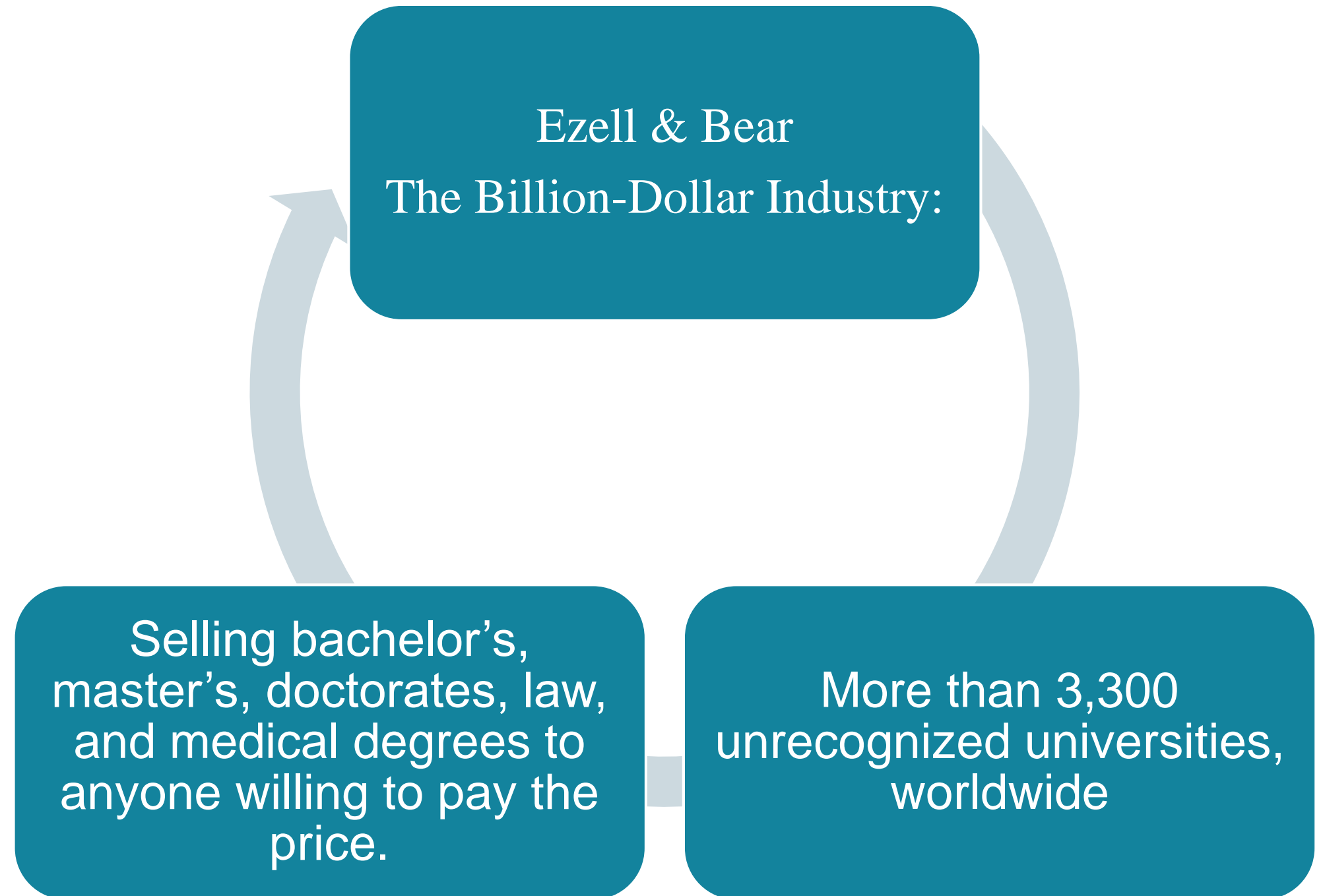

Counterfeit & Fraud Cases Middle East

1

2015 Counterfeit Ph.D. diplomas

1400 to Kuwait.

1,216 to UAE,

1198 to Saudi Arabia,

81 to Oman,

70 to Bahrain.

2

AXACT sold 200,000 fake diplomas to Middle East residents, mostly from the UAE and Saudi Arabia

3

Jordan: More than 3600 forged certificates annually

Certificate Forgery: USA

Annual Fake Degrees

Sold 450,000 fake degrees worth \$ Fake PhDs each year from diploma mills exceeds 50,000
450,000,000

Ph.D. Fake Degrees

50,000 Fake PhDs each year from diploma mills

Fake Medical Doctors

Currently more than 15,000 fake doctors in the USA.

Legacy Document Security

- Watermarks
- Ultraviolet
- Hologram
- Micro-printing
- Multi-color stamp
- Ultraviolet light on stamp
- Barcode
- Hidden Logo
- And others

INNOVATION

Jordan University of Science & Technology
Admission & Registration Unit
Irbid - Jordan

جامعة العلوم والتكنولوجيا الأردنية
وحدة القبول والتسجيل
إربد - الأردن

CERTIFICATE

The Deans' Council at Jordan University of Science and Technology
has decided at its meeting No. 23 /2007 dated 14-JUN-2007 to award

YOUSUF MEDHAT IHMAIDI AL-HMAID

born on 16-11-1984, holding the Jordanian nationality, his national no. 9841007353

Bachelor of Science in Nursing
from the Faculty of Nursing

He is hereby a graduate of the Second semester of the academic year 2006/2007.

With a G.P.A. of (69.2%), Average: Good

Revised By:- Sofan Amrb 23-04-2015 10:16:07
Printed By:- Abdallah Balbassy 05-11-2015 10:54:05
Student No. :- 20032040005

71415D043A676589

Director of Admission & Registration Unit
Amjad Al Wehsheh

357861
AR-706-F16

Shortcoming of Legacy Security System



Ineffective



**Paper security
can't prevent
counterfeit**



Costly



**Increase paper
security will
increase the cost**



Inefficient



**All security
features can be
forged**



Complex



**Requires
special
hardware for
verification**

Arab Student Clearinghouse Structure

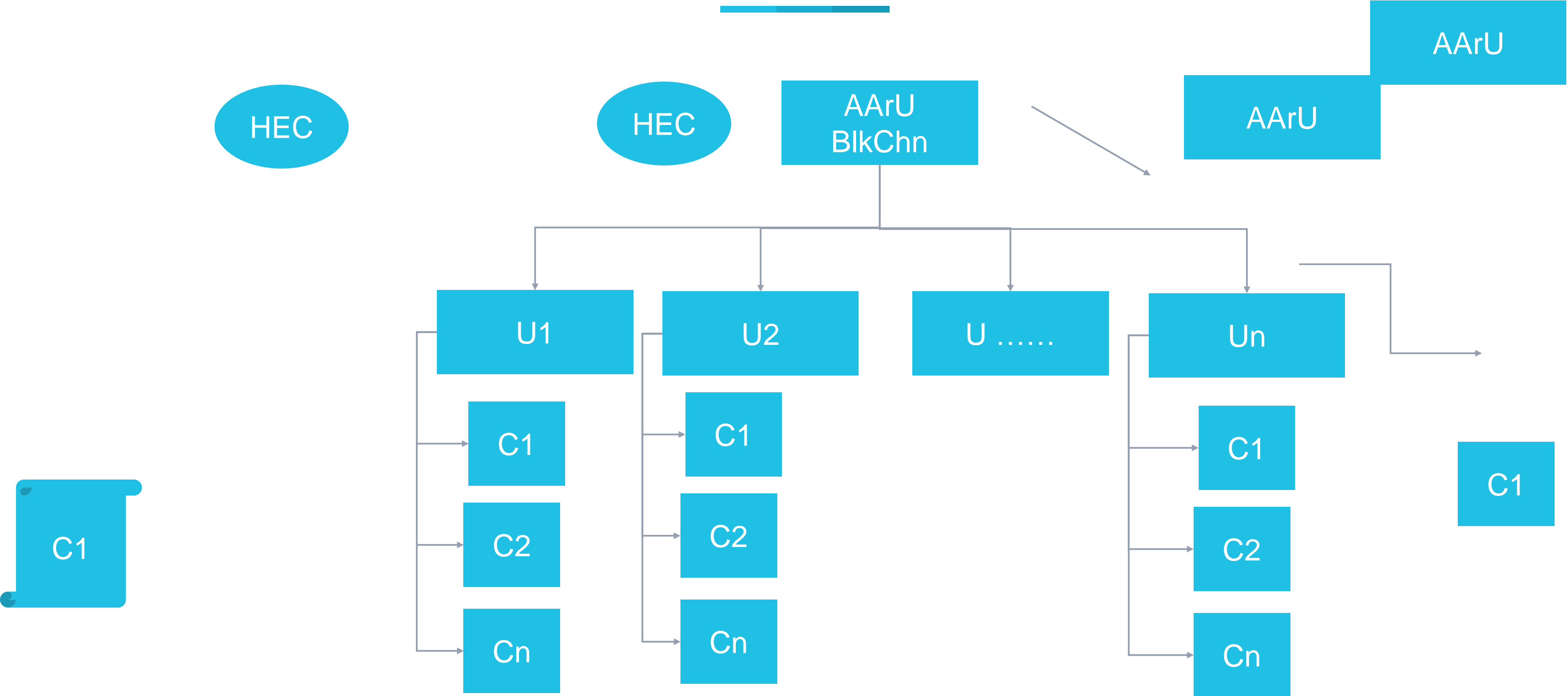

Clearinghouse System: Authentication Process

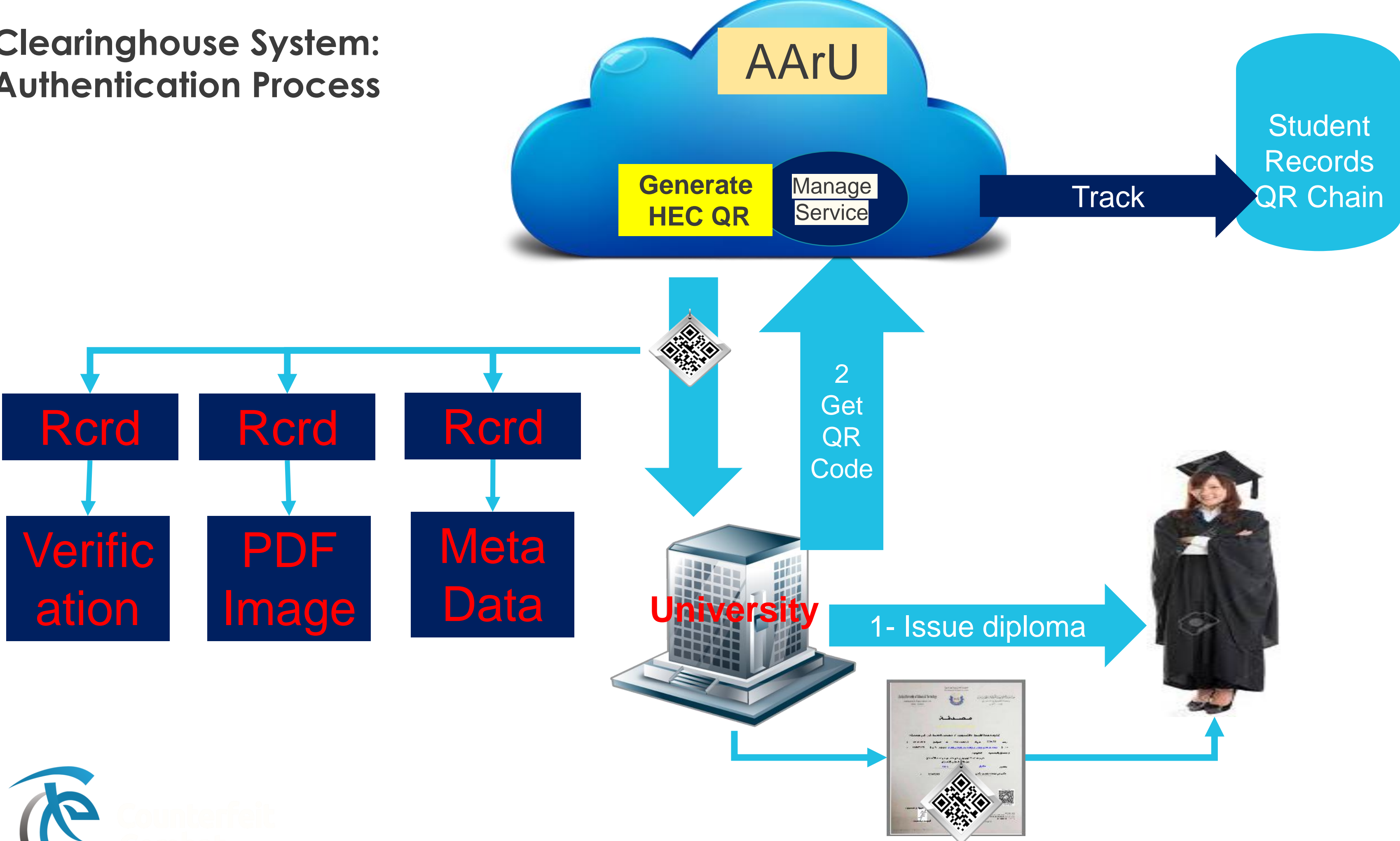

Clearinghouse System: Verification

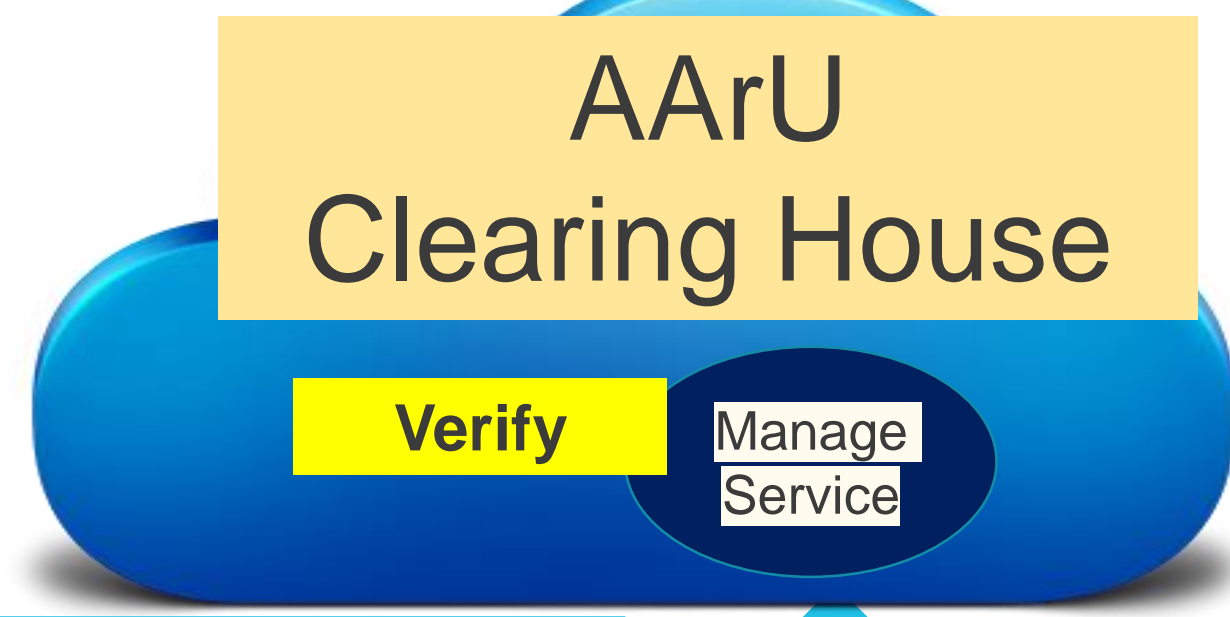

Verify and Update

Update Rcrd

Rcrd

Rcrd

Verific
ation

PDF
Image

Meta
Data



Send
HEC
QR
Code



Verify

Verify

Accept/Reject/Feedback

Scan using (verifycct.com/apps)



C3B8774F25F0698F

Examples

Jordan University of Science & Technology
Admission & Registration Unit
Irbid - Jordan

المملكة الأردنية الهاشمية
The Hashemite Kingdom of Jordan

جامعة العلوم والتكنولوجيا الأردنية
وحدة القبول والتسجيل
إربد - الأردن

CERTIFICATE

The Deans' Council at Jordan University of Science and Technology has decided at its meeting No. 23 /2007 dated 14-JUN-2007 to award

YOUSUF MEDHAT IHMAIDI AL-HMAID

born on 16-11-1984, holding the Jordanian nationality, his national no. 9841007353

Bachelor of Science in Nursing
from the Faculty of Nursing

He is hereby a graduate of the Second semester of the academic year 2006/2007.

With a G.P.A. of (69.2%), Average: Good

Reviewed By:- Sofan Amrb 23-04-2015 10:16:07
Printed By:- Abdallah Balfaway 05-11-2015 10:54:05
Student No. - 20032040005

748550036676589

Director of Admission & Registration Unit
Amjad Al Wehsheh

357861
AR-266-F16

Jordan University of Science & Technology
Admission & Registration Unit
Irbid - Jordan

المملكة الأردنية الهاشمية
The Hashemite Kingdom of Jordan

جامعة العلوم والتكنولوجيا الأردنية
وحدة القبول والتسجيل
إربد - الأردن

CERTIFICATE

The Deans' Council at Jordan University of Science and Technology has decided at its meeting No. 23 /2007 dated 14-JUN-2007 to award

YOUSUF MEDHAT IHMAIDI AL-HMAID

born on 16-11-1984, holding the Jordanian nationality, his national no. 9841007353

Bachelor of Science in Nursing
from the Faculty of Nursing

He is hereby a graduate of the Second semester of the academic year 2006/2007.

With a G.P.A. of (69.2%), Average: Good

Reviewed By:- Sofan Amrb 23-04-2015 10:16:07
Printed By:- Abdallah Balfaway 05-11-2015 10:54:05
Student No. - 20032040005

748550036676589

Director of Admission & Registration Unit

Back to CCTVify 12:11 PM 97%

cctstorage.blob.core.windows.net

Jordan University of Science & Technology
Admission & Registration Unit
Irbid - Jordan

المملكة الأردنية الهاشمية
The Hashemite Kingdom of Jordan

جامعة العلوم والتكنولوجيا الأردنية
وحدة القبول والتسجيل
إربد - الأردن

Based on the University Law, and in accordance with the recommendation of the Council of the Faculty of Medicine

The Deans' Council has decided to award

ADEY MATANI

Bachelor Degree in Medicine And Surgery
with all the rights, privileges and honors proper to it

Dean of the Faculty
Prof. Ismael I. Matalqa

Acting President of the University
Prof. Ahmad Bateha

Printed on the 5 Ramadan Year 1437 Hijri corresponding to the 8 June Year 2016
Certificate No. 1010-4596

For Verification Scan QR

1004020101940

Printed On - 21-06-2016 11:00:29

Jordan University of Science & Technology
Admission & Registration Unit
Irbid - Jordan

المملكة الأردنية الهاشمية
The Hashemite Kingdom of Jordan

جامعة العلوم والتكنولوجيا الأردنية
وحدة القبول والتسجيل
إربد - الأردن

اسم الطالب: **ياسين عبد المنعم عبد الطيف النشمي**
رقم الطالب: **20092010053**
تاريخ الترخيص: **09-10-1990** (42) تاريخ: **2016-06-26**

المعدل العام: **65.6%** (التقدير: **ممتاز**)
مجموع الدرجات المعتمدة التي أتم بها هذا العام: **257** من أصل **257** (معدل: **257**)
تاريخ: **2016-06-26**

رقم المقرر	اسم المقرر	الدرجة	ملاحظات
00100000	اللغة العربية	3	ممتاز
00100001	اللغة الإنجليزية	3	ممتاز
00100002	الرياضيات	3	ممتاز
00100003	الفيزياء	3	ممتاز
00100004	الكيمياء	3	ممتاز
00100005	التاريخ	3	ممتاز
00100006	الاجتماعيات	3	ممتاز
00100007	العلوم الطبيعية	3	ممتاز
00100008	العلوم الإنسانية	3	ممتاز
00100009	العلوم الصحية	3	ممتاز
00100010	العلوم الحاسوبية	3	ممتاز
00100011	العلوم الهندسية	3	ممتاز
00100012	العلوم الفيزيائية	3	ممتاز
00100013	العلوم الكيميائية	3	ممتاز
00100014	العلوم البيولوجية	3	ممتاز
00100015	العلوم البيئية	3	ممتاز
00100016	العلوم الاقتصادية	3	ممتاز
00100017	العلوم القانونية	3	ممتاز
00100018	العلوم السياسية	3	ممتاز
00100019	العلوم الاجتماعية	3	ممتاز
00100020	العلوم التربوية	3	ممتاز
00100021	العلوم الصحية	3	ممتاز
00100022	العلوم الحاسوبية	3	ممتاز
00100023	العلوم الهندسية	3	ممتاز
00100024	العلوم الفيزيائية	3	ممتاز
00100025	العلوم الكيميائية	3	ممتاز
00100026	العلوم البيولوجية	3	ممتاز
00100027	العلوم البيئية	3	ممتاز
00100028	العلوم الاقتصادية	3	ممتاز
00100029	العلوم القانونية	3	ممتاز
00100030	العلوم السياسية	3	ممتاز
00100031	العلوم الاجتماعية	3	ممتاز
00100032	العلوم التربوية	3	ممتاز
00100033	العلوم الصحية	3	ممتاز
00100034	العلوم الحاسوبية	3	ممتاز
00100035	العلوم الهندسية	3	ممتاز
00100036	العلوم الفيزيائية	3	ممتاز
00100037	العلوم الكيميائية	3	ممتاز
00100038	العلوم البيولوجية	3	ممتاز
00100039	العلوم البيئية	3	ممتاز
00100040	العلوم الاقتصادية	3	ممتاز
00100041	العلوم القانونية	3	ممتاز
00100042	العلوم السياسية	3	ممتاز
00100043	العلوم الاجتماعية	3	ممتاز
00100044	العلوم التربوية	3	ممتاز
00100045	العلوم الصحية	3	ممتاز
00100046	العلوم الحاسوبية	3	ممتاز
00100047	العلوم الهندسية	3	ممتاز
00100048	العلوم الفيزيائية	3	ممتاز
00100049	العلوم الكيميائية	3	ممتاز
00100050	العلوم البيولوجية	3	ممتاز
00100051	العلوم البيئية	3	ممتاز
00100052	العلوم الاقتصادية	3	ممتاز
00100053	العلوم القانونية	3	ممتاز
00100054	العلوم السياسية	3	ممتاز
00100055	العلوم الاجتماعية	3	ممتاز
00100056	العلوم التربوية	3	ممتاز
00100057	العلوم الصحية	3	ممتاز
00100058	العلوم الحاسوبية	3	ممتاز
00100059	العلوم الهندسية	3	ممتاز
00100060	العلوم الفيزيائية	3	ممتاز
00100061	العلوم الكيميائية	3	ممتاز
00100062	العلوم البيولوجية	3	ممتاز
00100063	العلوم البيئية	3	ممتاز
00100064	العلوم الاقتصادية	3	ممتاز
00100065	العلوم القانونية	3	ممتاز
00100066	العلوم السياسية	3	ممتاز
00100067	العلوم الاجتماعية	3	ممتاز
00100068	العلوم التربوية	3	ممتاز
00100069	العلوم الصحية	3	ممتاز
00100070	العلوم الحاسوبية	3	ممتاز
00100071	العلوم الهندسية	3	ممتاز
00100072	العلوم الفيزيائية	3	ممتاز
00100073	العلوم الكيميائية	3	ممتاز
00100074	العلوم البيولوجية	3	ممتاز
00100075	العلوم البيئية	3	ممتاز
00100076	العلوم الاقتصادية	3	ممتاز
00100077	العلوم القانونية	3	ممتاز
00100078	العلوم السياسية	3	ممتاز
00100079	العلوم الاجتماعية	3	ممتاز
00100080	العلوم التربوية	3	ممتاز
00100081	العلوم الصحية	3	ممتاز
00100082	العلوم الحاسوبية	3	ممتاز
00100083	العلوم الهندسية	3	ممتاز
00100084	العلوم الفيزيائية	3	ممتاز
00100085	العلوم الكيميائية	3	ممتاز
00100086	العلوم البيولوجية	3	ممتاز
00100087	العلوم البيئية	3	ممتاز
00100088	العلوم الاقتصادية	3	ممتاز
00100089	العلوم القانونية	3	ممتاز
00100090	العلوم السياسية	3	ممتاز
00100091	العلوم الاجتماعية	3	ممتاز
00100092	العلوم التربوية	3	ممتاز
00100093	العلوم الصحية	3	ممتاز
00100094	العلوم الحاسوبية	3	ممتاز
00100095	العلوم الهندسية	3	ممتاز
00100096	العلوم الفيزيائية	3	ممتاز
00100097	العلوم الكيميائية	3	ممتاز
00100098	العلوم البيولوجية	3	ممتاز
00100099	العلوم البيئية	3	ممتاز
00100100	العلوم الاقتصادية	3	ممتاز

Solution Benefits

Secure iVerify Application

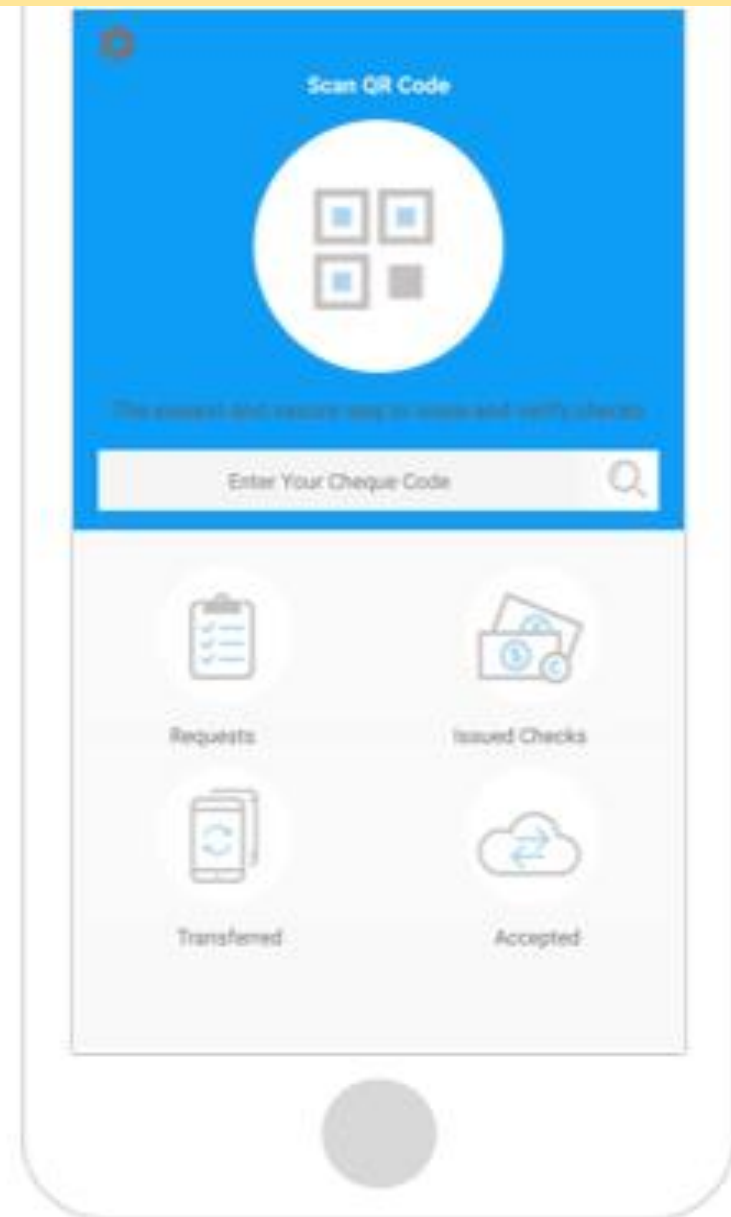

1

AC-QR is the DNA of the document

2

Protect against : certificate issued by wrong institute, altered after issuing,

3

Trace and monitor certificate verification

4

Real account for certificate and degree verification

5

Data statistics on graduating students

6

Easy and simple certificate verification

7

Auto management of certificate and degrees

8

Independent portals for AArU and universities

Extraordinary Value

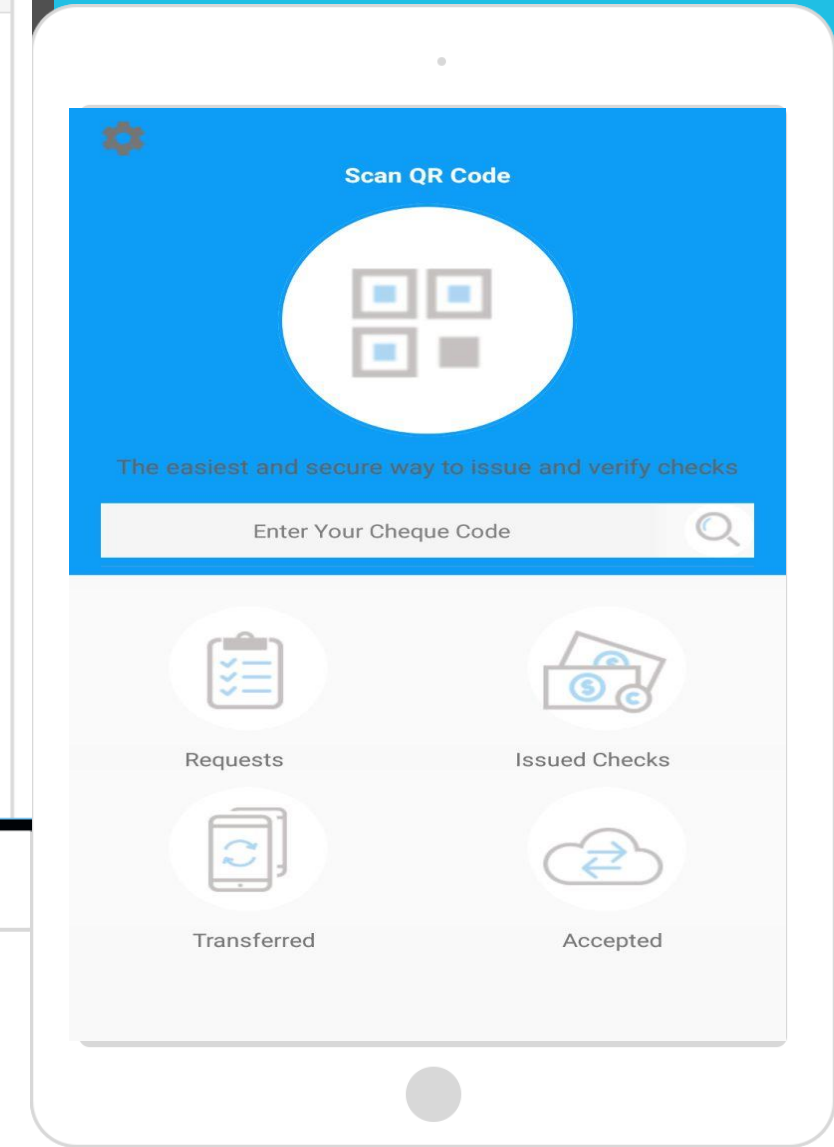
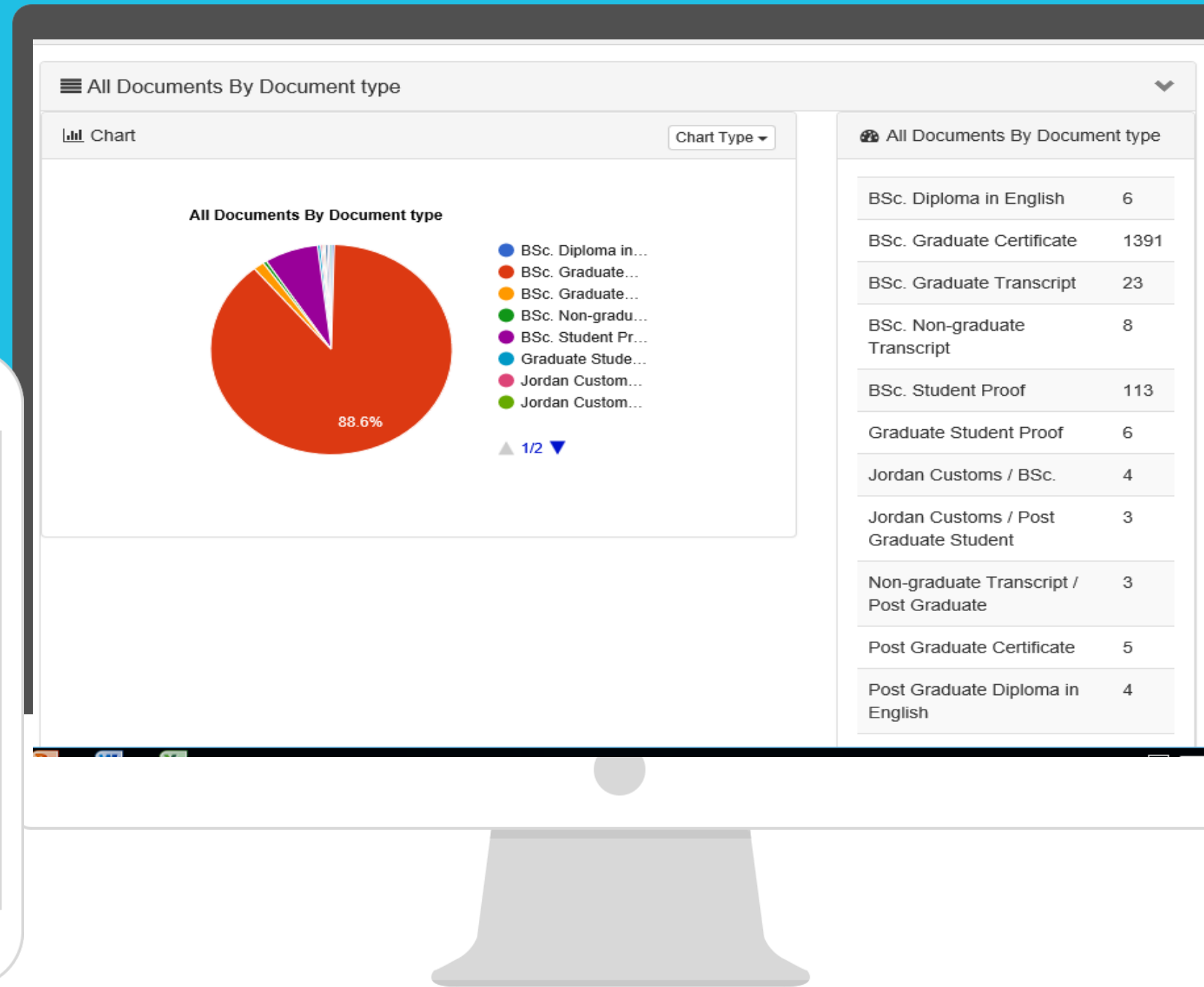
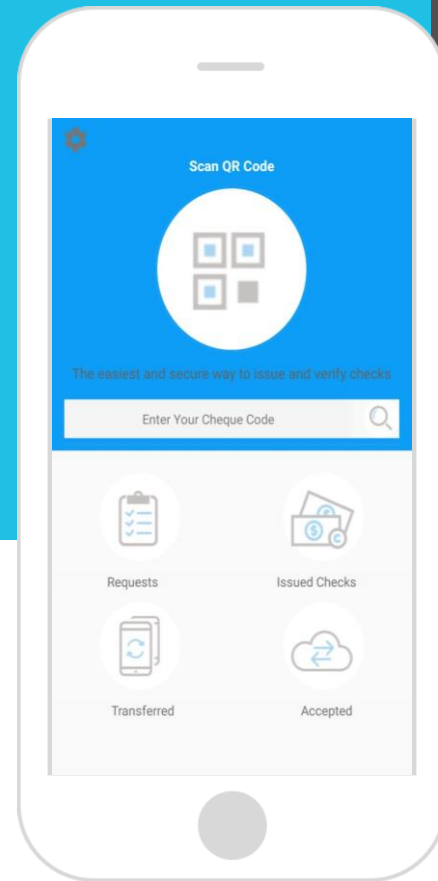

Anytime, anywhere Statistics

Real-time statistics of documents activities

Solution: CCT Dashboard Site: Authentication

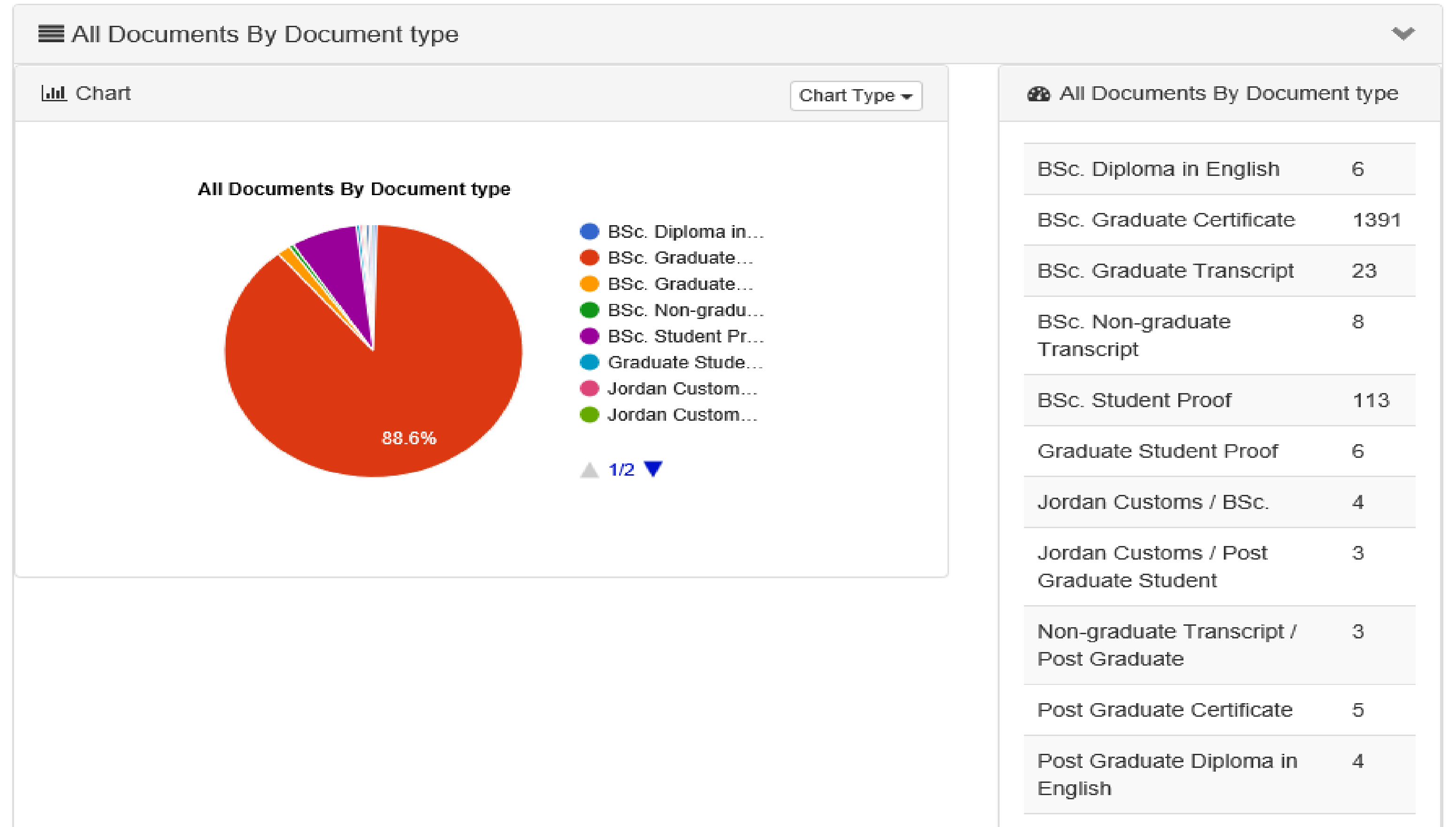

Solution: CCT Dashboard Site: Authentication

☰ All Documents By Document **type** >

☰ Documents Verification Charts ▾

📊 Chart

Chart Type ▾

Verification Requests by document type

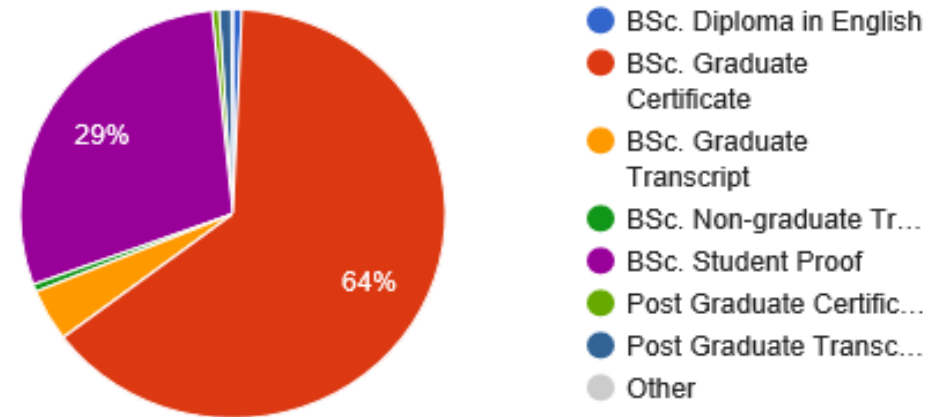

🌐 Verification Requests by document type

BSc. Diploma in English	30
BSc. Graduate Certificate	2819
BSc. Graduate Transcript	181
BSc. Non-graduate Transcript	26
BSc. Student Proof	1279
Graduate Student Proof	2
Non-graduate Transcript / Post Graduate	1
Post Graduate Certificate	23
Post Graduate Diploma in English	2
Post Graduate Transcript	41

Verifications for Jordan Diplomas – by Geographic Locations

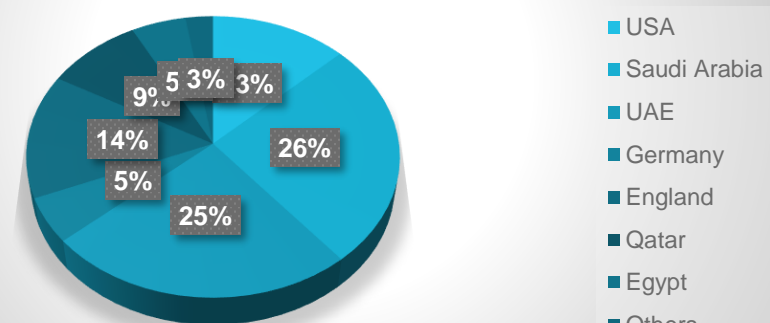

AARU Commitment



Security

- Data Storage:
 - data integrity check
 - authentication and authorization
- Data Transfer:
 - secure over https
 - end-to-end encryptions

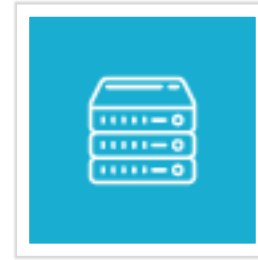

Performance

- Cloud Technology
- High performance computing
- Scale on demand



Reliability & Availability

- Automated protection and replication
- Remote health monitoring
- Orchestrated recovery when needed

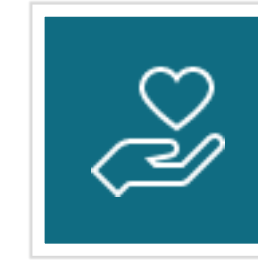

User Friendly

- Uniform look and feel
- Easy to use
- Multi language Support

5

Benefits

Benefits of Stakeholders



- ✓ National economy and security
- ✓ Higher Education Ministries
- ✓ University
- ✓ Students



Benefits for University

One Clearinghouse for all – 100% Anti-Fraud & Counterfeit

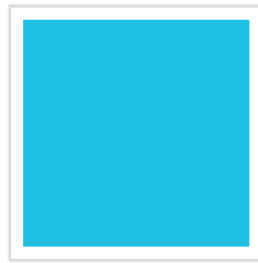

Tracking

Trace and **Monitor**
students/graduates
documents

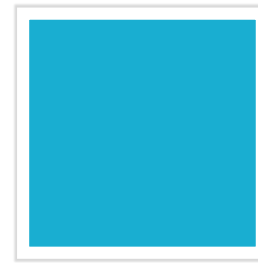

Control

Deactivate /
Reactivate
documents



Stats

Statistics for
authenticated and
verified
documents

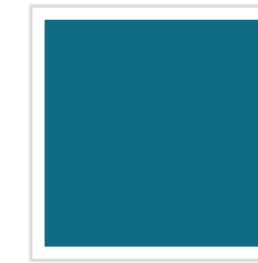

Save time & Money

Reduce cost and
burden of
verification &
Generate money

Benefits for Student



Time saving

Simple and fast verification process



Cost Saving

Reduced overall verification cost



Value

Adding security and counterfeit protection value to the document



Peace of Mind

Obtain certificates at anytime, any condition, anywhere

Benefits for Verifier



Time saving

Simple and fast verification process



Cost Saving

Reduced or no cost for verification



Value

Guaranteed security and trust of documents authenticity



Current Members

01

MOHE Jordan

02

Jordan Medical Board

03

Association of Arab
Universities

04

Yarmouk University

05

Islamic University
Jordan

06

JUST University

07

Amman Ahilyah
University

08

Jadara University

09

Sumayya
University

10

Fahd Bin Sultan University
Saudi Arabia

09

Irbid Ahliyah

“There are only two ways to live your life.
One is as though nothing is a miracle.
The other is as though everything is a miracle.”
(Albert Einstein)

“You can create your own miracle”
(CCT)



Get in touch – Join AArU Authentication/Verification System

- secgen@aaruedu.jo
- Mohammad.jilani@cctinc.com

Thank you!
